

AN-1811 Bluetooth Antenna Design

ABSTRACT

This application note is intended for designers using the LMX5251 or LMX5252 Bluetooth® radio chips or LMX9820A or LMX9830 Bluetooth modules. Antenna design for various applications is described along with theory, matching circuit description, suppliers and examples.

Contents

1	Introduction	3
2	Theory	3
3	Layout	7
	3.1 PIFA Antenna	7
	3.2 Ceramic Dielectric Antenna	8
	3.3 Examples of 2.4-GHz PIFA Antennas	10
	3.4 LMX9820/A Antennas	11
	3.5 LMX9830 Antenna	12
4	Matching	12
	4.1 Network Analyzer Calibration	12
	4.2 Measurement	13
	4.3 Tuning the Impedance	14
	4.4 PI-Network Matching	15
	4.5 Matching to a Non-50Ω Active Source/Load Impedance	19
5	Interference Rejection	22
	5.1 Filtering	22
	5.2 Blocking	24
	5.3 Recommended Front-end Layout and Matching	24
6	Antenna Vendors	25
7	Comparison Summary	26
8	Points for Consideration	26
9	Examples of Antennas Used With LMX5251/LMX5252	27
10	Popular Antenna Types	30

List of Figures

1	Fringing Field With Full Ground Plane	4
2	Fringing Field With Partial Ground Plane	5
3	Antenna Radiation Pattern	6
4	Return Loss	7
5	Printed Inverted-F Antenna (PIFA)	7
6	PIFA Antenna Placement	8
7	Ceramic Dielectric Antenna Placement	9
8	Typical Chip Dimensions	9
9	Typical Chip PCB Footprint	10
10	LMX5251 PIFA Antenna	10
11	LMX5252 PIFA Antenna	11
12	LMX9820A Antenna	11

All trademarks are the property of their respective owners.

13	LMX9830 Antenna.....	12
14	Return Loss, No Connection.....	13
15	Smith Chart, Perfect Short.....	13
16	Return Loss, Antenna Connected.....	14
17	Smith Chart, Antenna Connected.....	14
18	Impedance Transformation.....	15
19	Impedance Matching Network.....	15
20	Single Frequency Data Point.....	16
21	After Resistance-Conductance Tuning.....	16
22	After Conductance-Resistance Tuning.....	17
23	Two Possible Matching Networks.....	17
24	Broadband Match.....	18
25	PI Network.....	18
26	Component Models.....	19
27	Matching to Non-50Ω Impedance.....	20
28	Setup for Determining Output Impedance.....	21
29	RF Filter Performance.....	22
30	LC Filter Response.....	23
31	Front-end Layout Using Ceramic Filter.....	25
32	Front-end Layout Using T PI Pad.....	25
33	Ceramic Chip Antenna for Industrial Remote Control with External PA.....	27
34	Printed Antenna—Monopole Yagi-Array for Off-Board Navigation Using GPS.....	27
35	Ceramic Chip Antenna for Intelligent Remote Access for Car Lock.....	28
36	Ceramic Chip Antenna for Distance Meter.....	28
37	External Antenna—Helix or Monopole for Automotive Integrated Hands-Free Kit.....	29
38	Printed PIFA Antenna for Automotive Hands-Free Kit.....	29
39	Surface-Mount Chip Antenna (Phycomp AN-2700 or Murata ANCM12G) for Automotive Hands-Free Kit ...	30
40	Surface-Mount Chip Antenna (Mitsubishi Materials AHD 1403) for Electronic Whiteboard.....	30
41	GigaAnt Rufa 2.4 GHz SMD Antenna.....	31
42	Mitsubishi AHD1403 Surface-Mount Antenna.....	31

List of Tables

1	Chip Filter Specifications.....	23
2	Blocking Signal Level and Frequency.....	24
3	Antenna Vendors.....	25
4	Antenna Comparison.....	26

1 Introduction

Any structure that is resonant at 2.45 GHz with bandwidth more than 100 MHz and efficiency >50% can be considered a Bluetooth antenna. Therefore, a countless variety of antennas can be used, and they are application-specific. Some common types are:

- *Wire Monopole* — This consists of a simple wire soldered at one end from which it is fed against a ground plane. It is trimmed to be resonant at 2.45 GHz and provides good performance and high efficiency. The disadvantage of this antenna is that it is not low profile because it projects above the PCB.
- *PIFA* — The Printed Inverted F Antenna is like a monopole printed on a PCB, but it has a ground point and feed point along the main resonant structure.
- *Helix* — Similar to the wire monopole, except that it is coiled around a central core (usually air) making the physical dimensions smaller. It provides excellent performance, but projects above the PCB.
- *Ceramic* — Surface mount dielectric antennas are the smallest types of antennas available, because they are printed on a high-dk ceramic slab, which makes the electric field concentrated allowing the antenna to be made small while keeping a high resonant frequency.

This application note only describes PIFA and ceramic antennas because they are the most common, low-profile, smallest, and inexpensive types available.

2 Theory

Printed and surface-mount antennas have certain common properties. Area around and beneath the radiating element must be kept copper-free. The ground plane must be placed on one side of the radiating element. Bandwidth is >100 MHz with VSWR <2.5 and efficiency >60%.

The antenna will detune if any object is placed close to it (in its near field). This has an effect of pulling the frequency, which must be retuned to 2.45 GHz.

An oscillating or constantly accelerating charge is critical in producing propagating waves. A static or non-accelerating charge will result in a non-propagating electric field. But this is not the only condition for radiation. For example, consider a printed $\lambda/4$ element on microstrip, as shown in [Figure 1](#).

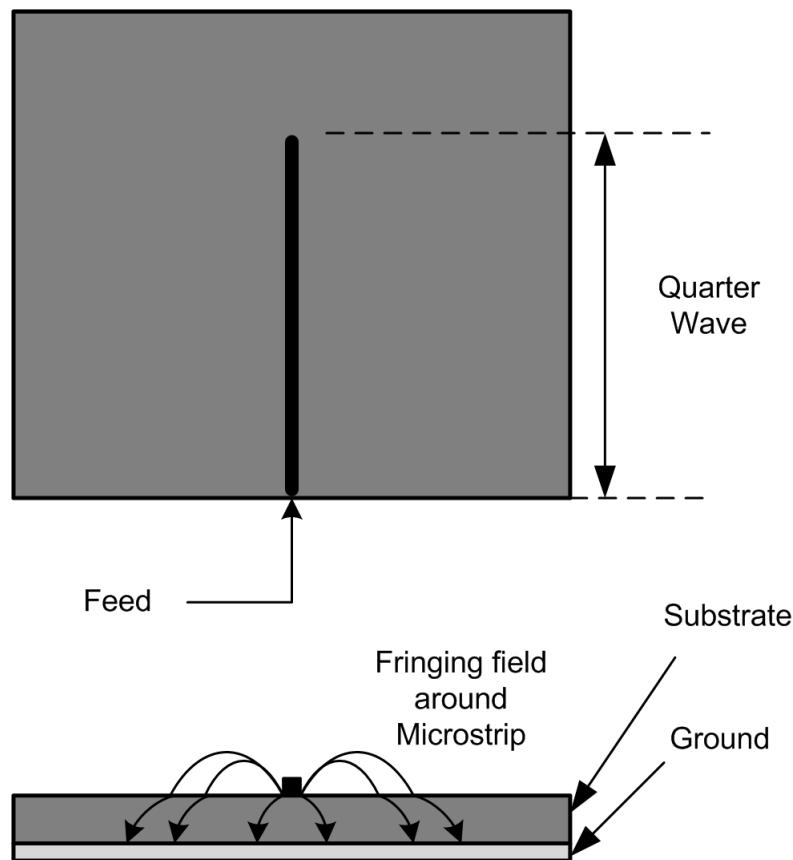

Figure 1. Fringing Field With Full Ground Plane

The fringing field around the microstrip due to the ground plane directly underneath the substrate will be confined to a small area. If a network analyzer is connected to the feed point, it would indicate a high VSWR and narrow bandwidth. This means very little radiation is being emitted from the microstrip element.

To increase the radiation emission and achieve greater bandwidth, the ground plane must be moved away from the microstrip element which makes the fringing field cover more distance, as shown in [Figure 2](#). But it should be noted that if the ground plane is moved too far, then the fringing field stops altogether, and there is no radiation. Therefore, the position and size of the ground plane is vital in the design of a good radiator.

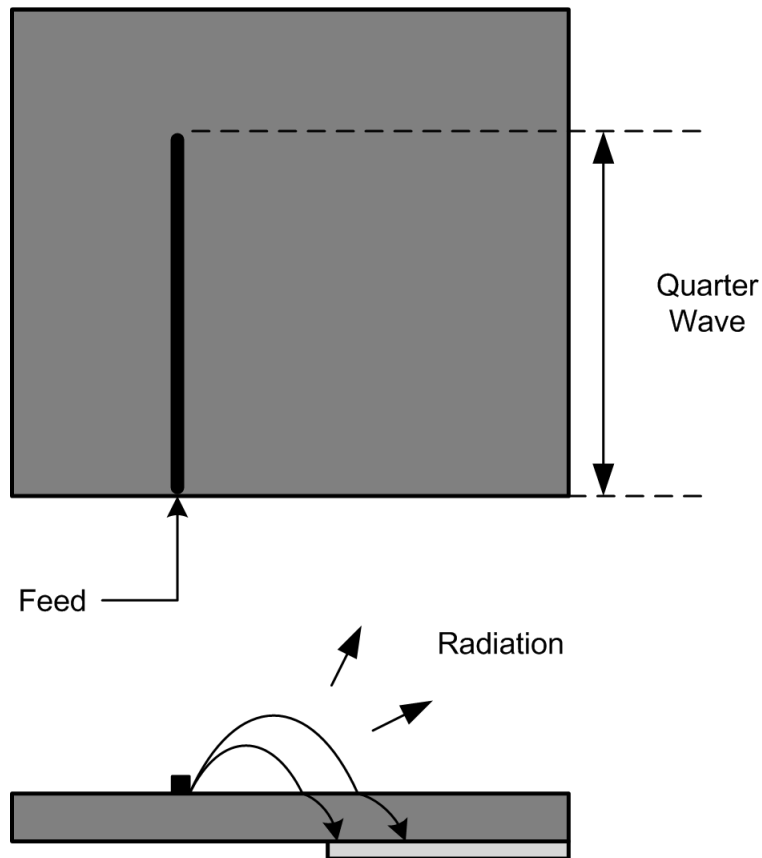

Figure 2. Fringing Field With Partial Ground Plane

The antenna could be imagined as an impedance transformer, transforming the impedance of a microstrip line (50Ω) to that of free space (377Ω), which allows the power to be transferred from a guided wave to a free-space wave.

The radiation pattern from such antennas in which the physical size is much smaller than wavelength ($L \ll \lambda$) is almost symmetrical in all directions, as shown in [Figure 3](#). The pattern can be controlled only when L is similar or greater than λ .

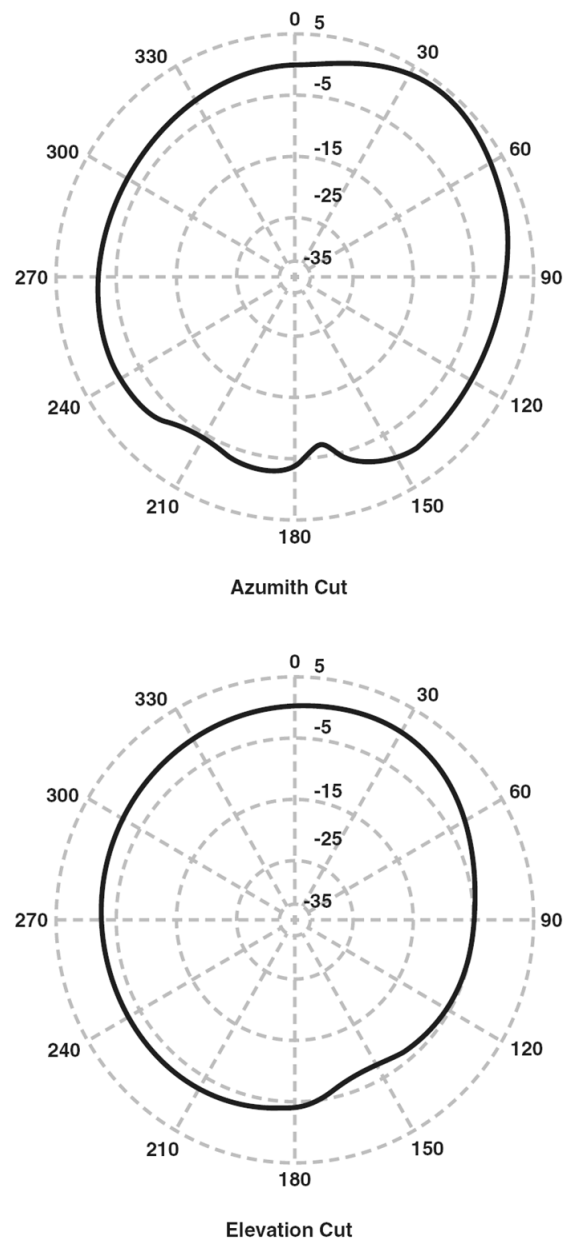

Figure 3. Antenna Radiation Pattern

Input return loss when viewed on a network analyzer looks like that shown in [Figure 4](#), with the full band covered with $VSWR < 2$. This gives very good matching into the antenna, however in real conditions when the antenna is detuned due to handling or placement of components close to it, a VSWR of 3 to 4 is typical.

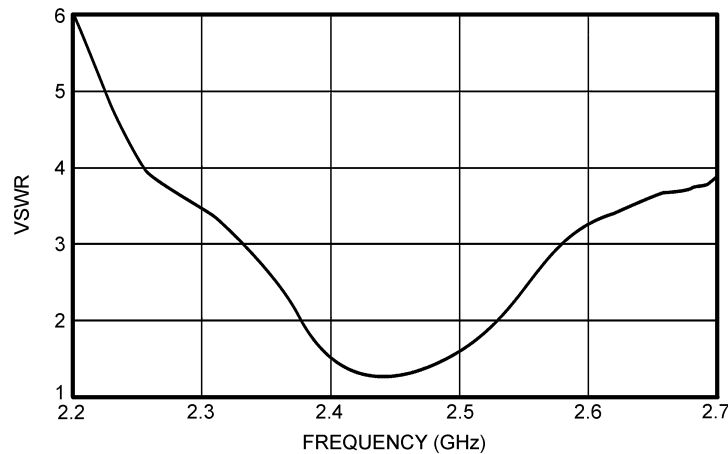

Figure 4. Return Loss

3 Layout

3.1 PIFA Antenna

The typical length of a 2.45-GHz resonant printed antenna is 20 to 25 mm, depending on the thickness of the substrate and dielectric constant. Copper clearance is required around the radiating element which is fed from a point along it, as shown in Figure 5. The position of the feed can be used to control the input impedance into the antenna. The ground plane required on one side of the antenna is approximately 20 mm wide. If it were any smaller, it will start to reduce the bandwidth at the input. Good design practice is to have a three-element matching network going into the feed, to give some additional tuning ability if required. To obtain the exact dimensions of the design, input impedance and bandwidth would have to be simulated over the frequency band using an antenna simulation package. Alternatively an antenna manufacturer can be contacted that has the capability to make such a design.

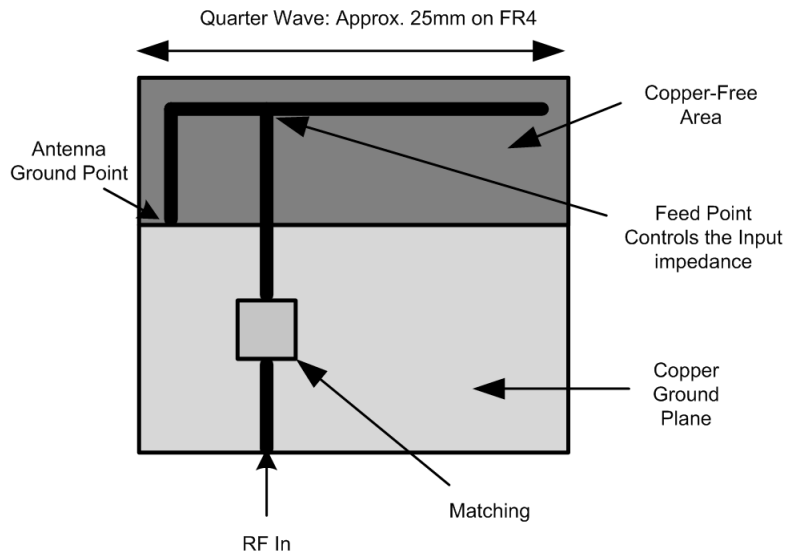

Figure 5. Printed Inverted-F Antenna (PIFA)

The PIFA is placed on the edge of the motherboard PCB, as shown in Figure 6. The area around the corner is kept copper-free, and any components such as the shielding that come close to the PIFA may pull its frequency. This can be retuned by milling the end of the radiating element. The LMx5251/LMx5252 and its surrounding components do not need shielding unless they are very close to the radiating element.

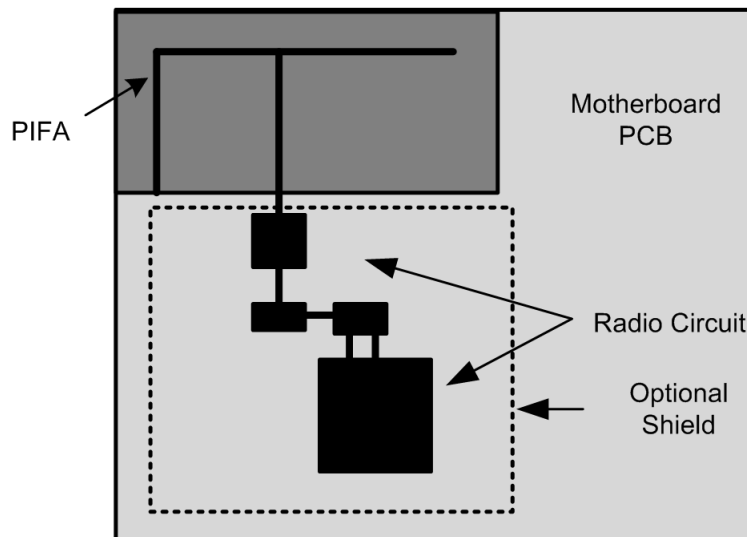

Figure 6. PIFA Antenna Placement

3.2 Ceramic Dielectric Antenna

A ceramic dielectric antenna is smaller than a PIFA or any other PCB antenna because the active element is wound around a high-dk ceramic slab, which concentrates the electric field. As with a PIFA, a copper-cleared area and a ground plane are required, as shown in [Figure 7](#). A smaller ground plane can be used, at the expense of bandwidth and efficiency.

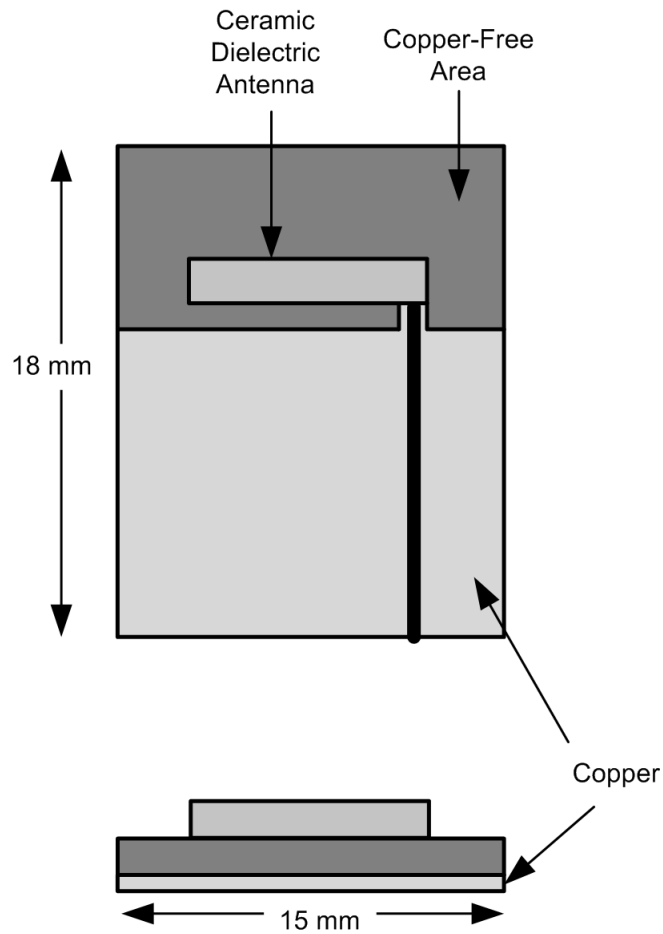

Figure 7. Ceramic Dielectric Antenna Placement

An example antenna from Mitsubishi with details of the ceramic element dimensions is shown in [Figure 8](#).

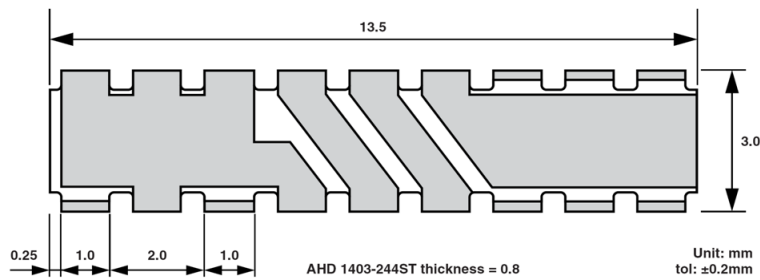

Figure 8. Typical Chip Dimensions

The land pattern required for mounting on the PCB is shown in [Figure 9](#).

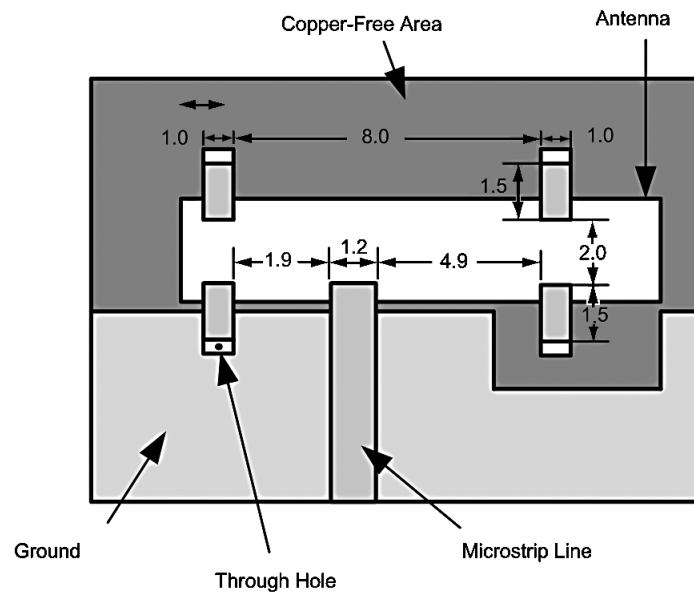

Figure 9. Typical Chip PCB Footprint

The ceramic dielectric antenna behaves similarly to a PIFA, in that it can be detuned, has a symmetrical radiation pattern, and has an efficiency of approximately 70%.

3.3 Examples of 2.4-GHz PIFA Antennas

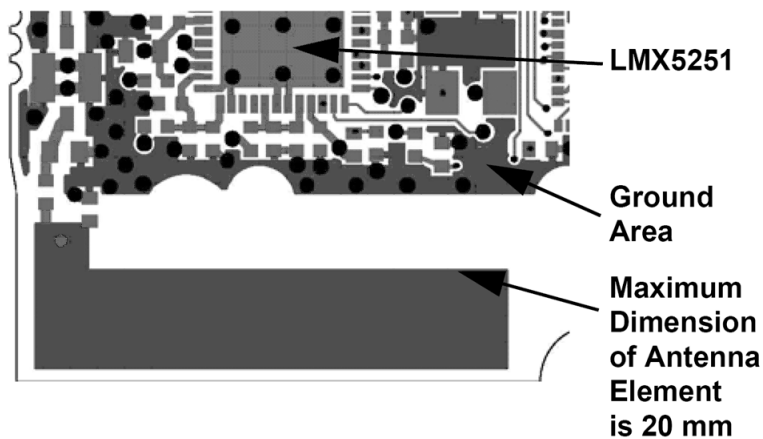

Figure 10. LMX5251 PIFA Antenna

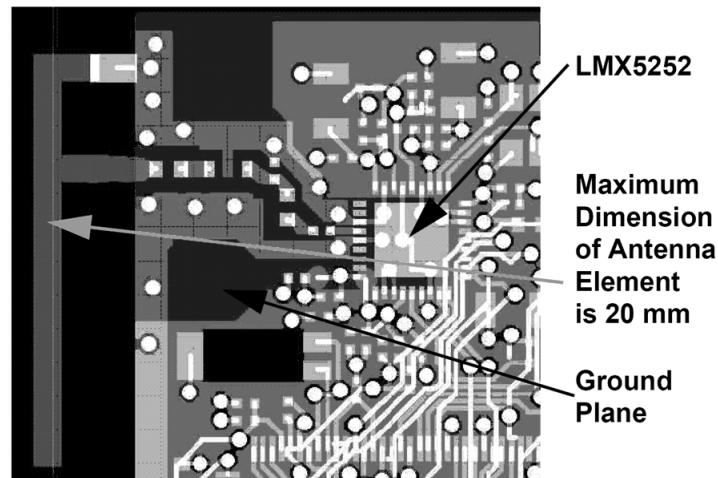

Figure 11. LMX5252 PIFA Antenna

3.4 LMX9820/A Antennas

The LMX9820 and LMX9820A are packaged as shielded LTCC and FR4 modules, approximately 14 × 10 mm in size. The design of its antenna is very similar to that of the LMX5251/LMX5252, but the shielding makes two differences. First, the metal shield protects the components in the module from the electric field of the antenna, so it is possible to place the LMX9820A much closer to the antenna element. Second, the shielding also acts as a ground plane, so less unpopulated ground area is required around the radiating element.

In the example using a ceramic dielectric antenna shown in Figure 12, the module is placed close to the radiating element. The electric field from the antenna couples to the surface of the shielded enclosure producing propagating radiation. If the shield is well-grounded, there will be no adverse effects on the components inside.

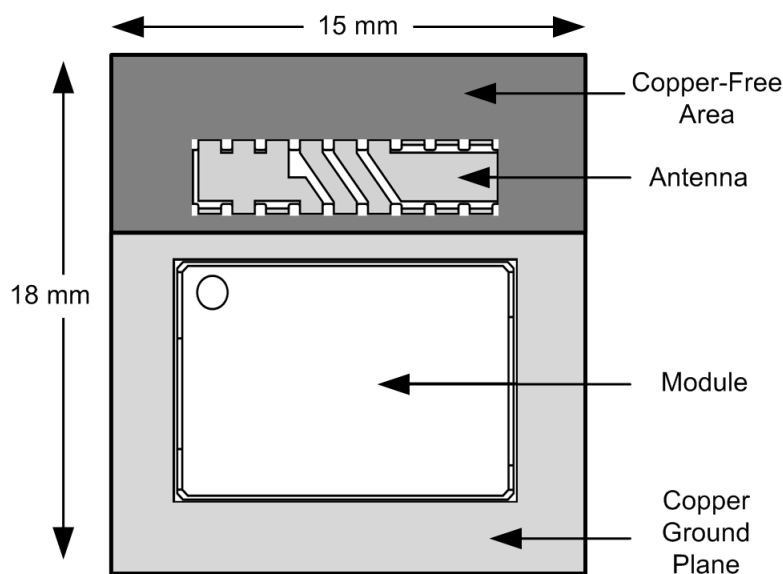

Figure 12. LMX9820A Antenna

3.5 LMX9830 Antenna

The LMX9830 is smaller than the 9820/A, approximately 6 × 9mm, however it is unshielded within a plastic package and so there are some important changes that need to be taken into account. It cannot be placed as close to the antenna active element, else the E-field may give rise to unwanted coupling effects, also the E-field from the antenna element will couple through the main body of the module to the ground plane underneath. PCB ground plane under the module is therefore important.

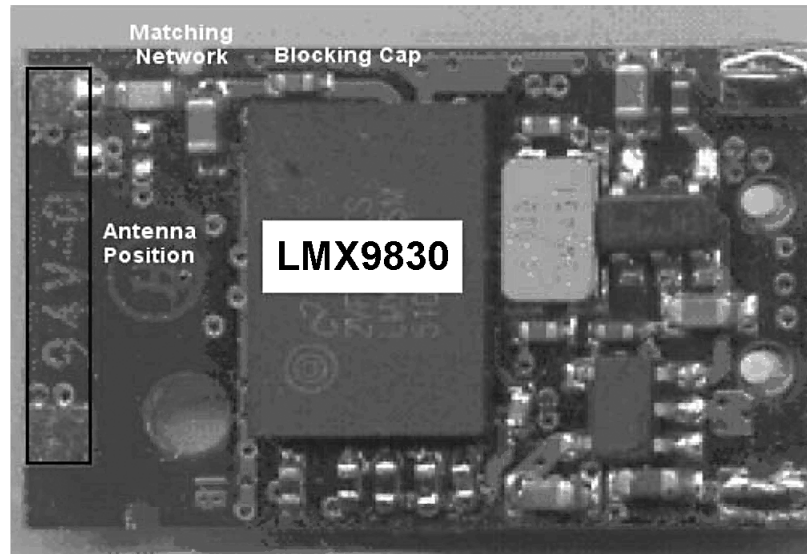

Figure 13. LMX9830 Antenna

4 Matching

Purchased antennas, such as surface-mount ceramic dielectric antennas, will be matched to 50Ω input impedance with return loss <-7dB over 100 MHz bandwidth, centered at 2.45 GHz. However, this is only as measured on the manufacturers test board, in free space. Taking this antenna and putting it on the application PCB, in which the ground-plane layout may be different or there may be detuning components such as filters placed nearby, will pull the resonant frequency of the antenna away from 2.45 GHz. The antenna therefore needs matching to the correct frequency. This can be achieved by means of a three-element PI network, placed at the input to the antenna. Usually a capacitor pair and an inductor, or an inductor pair and a capacitor, will give sufficient tuning ability.

There are three steps to matching:

1. The network analyzer must be calibrated accurately with the electrical delay removed.
2. An impedance measurement from 2.300 to 2.600 GHz of the return loss and a Smith-Chart plot.
3. Matching by placing capacitors and/or inductors onto the PCB to see how the impedance is changed.

4.1 Network Analyzer Calibration

The network analyzer should be calibrated for S11, one-port only measurements using the open, short, and load standard provided. A flat line should be obtained when the standards are removed as shown in Figure 14.

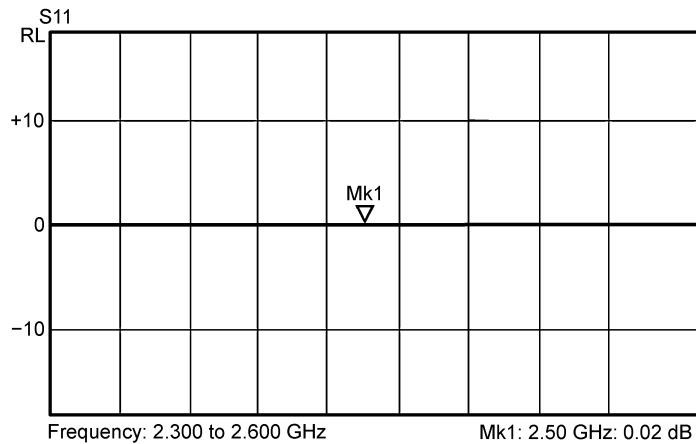

Figure 14. Return Loss, No Connection

Before soldering the semi-rigid cable to the PCB, it is connected to the end of the network analyzer cable, and the electrical delay is adjusted with the end of the semi-rigid cable shorted. Use a short cable attachment (less than 5 cm), otherwise the electrical delay will be too long. Electrical delay is adjusted until it is measuring a perfect short on the Smith Chart as shown in [Figure 15](#).

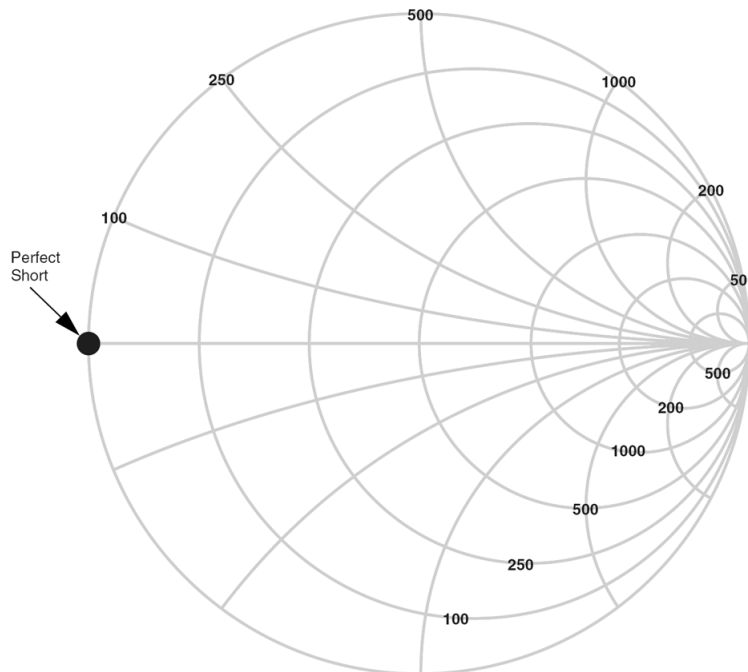

Figure 15. Smith Chart, Perfect Short

4.2 Measurement

Attach the semi-rigid cable to the PCB and ground it at a point close to the end of the cable. When measuring the input impedance of the antenna, it is important to have the setup on a wooden or non-detuning surface and to keep your hands away from the setup, otherwise the measurement will be incorrect. An example of a typical return loss measurement is shown in [Figure 16](#).

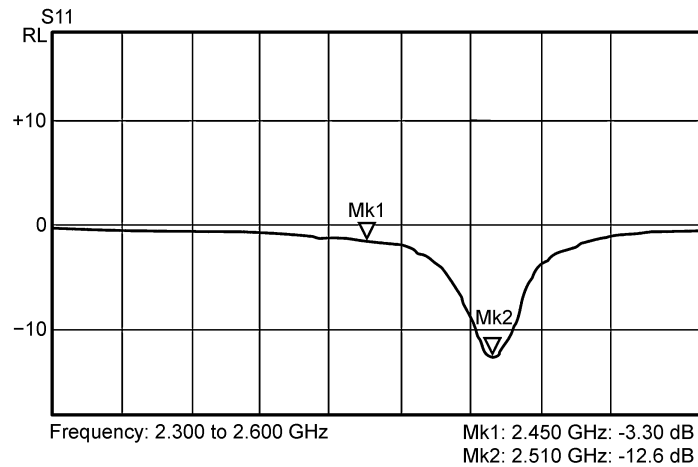

Figure 16. Return Loss, Antenna Connected

In this example, the resonant frequency of the antenna is 60 MHz too high. At the desired frequency, the return loss is only -3.3 dB.

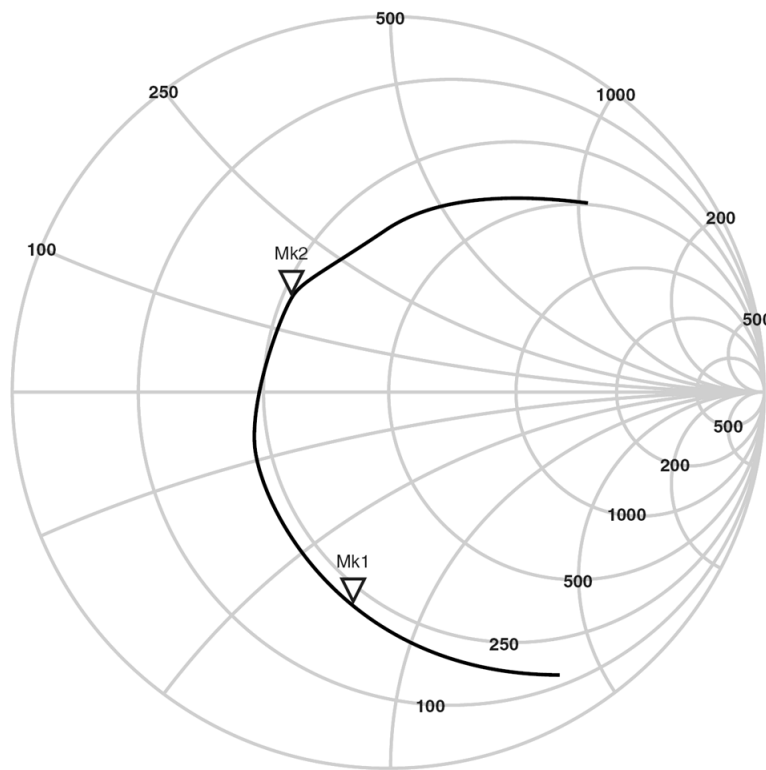

Figure 17. Smith Chart, Antenna Connected

4.3 Tuning the Impedance

After taking an accurate measurement of the input impedance, it can be tweaked using the matching components on the three-element PI network. Marker 1 impedance has to be transformed to 50Ω, as shown in Figure 18.

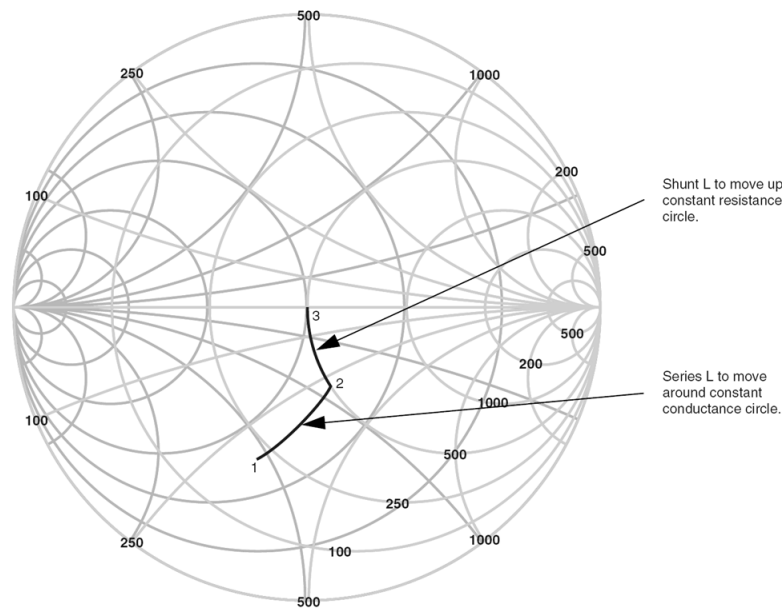

Figure 18. Impedance Transformation

Starting from the impedance point that needs to be matched (point 1), add a 1.8-nH series inductor to move from point 1 to 2. A shunt inductor will transform the impedance at point 2 to the center of the chart, which is the normalized 50Ω impedance point. The matching network is shown in Figure 19.

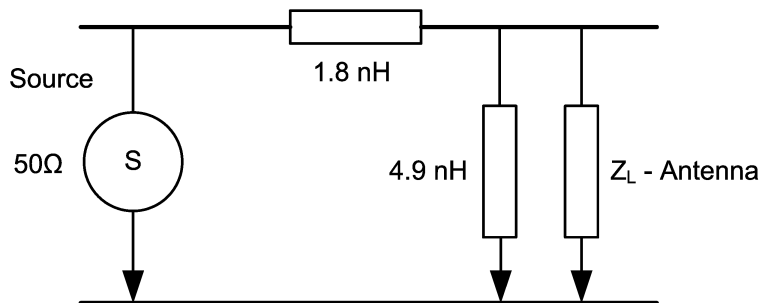

Figure 19. Impedance Matching Network

This is only a theoretical matching circuit. In reality, the inductors have parasitic resistance and capacitance, so the impedance will not be transformed as cleanly as shown on the Smith Chart. Also, the exact values shown above may not be available in a standard kit. Some trial and error is required to get the exact match required.

4.4 PI-Network Matching

A popular type of matching network is the PI-network, consisting of two shunt components with one series component in the middle. This provides flexibility for retuning a detuned antenna. Even though only two components are normally used for matching the load to the source, it allows putting the shunt component either before or after the series component.

For example, consider the data point on the Smith Chart: $(10.2 + j30.1)\Omega$ shown in Figure 20.

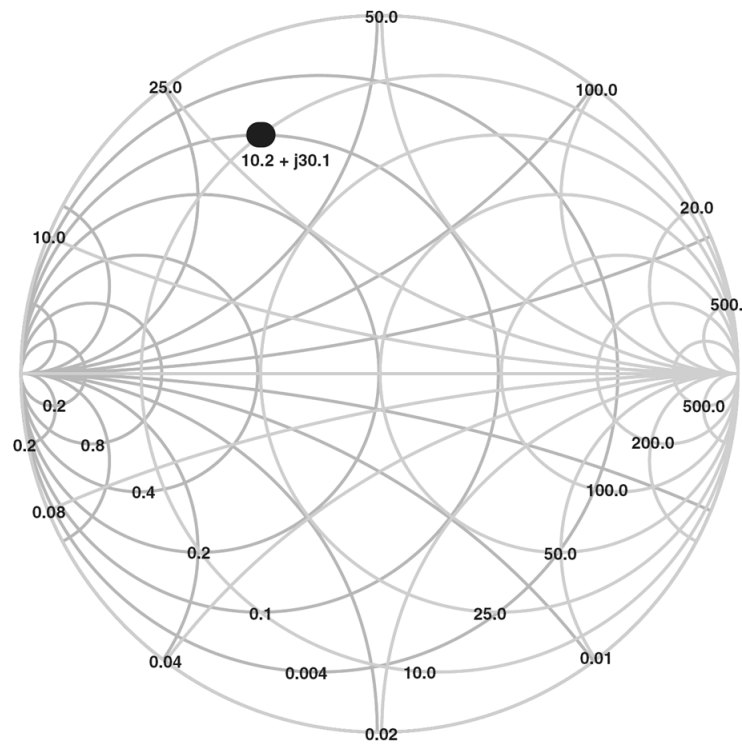

Figure 20. Single Frequency Data Point

There are two methods for matching to the load. The first technique is to move around a constant resistance circle from position 1 to 2 by adding a series capacitance and then from 2 to 3 around a constant conductance circle by adding a shunt capacitance, as shown in [Figure 21](#).

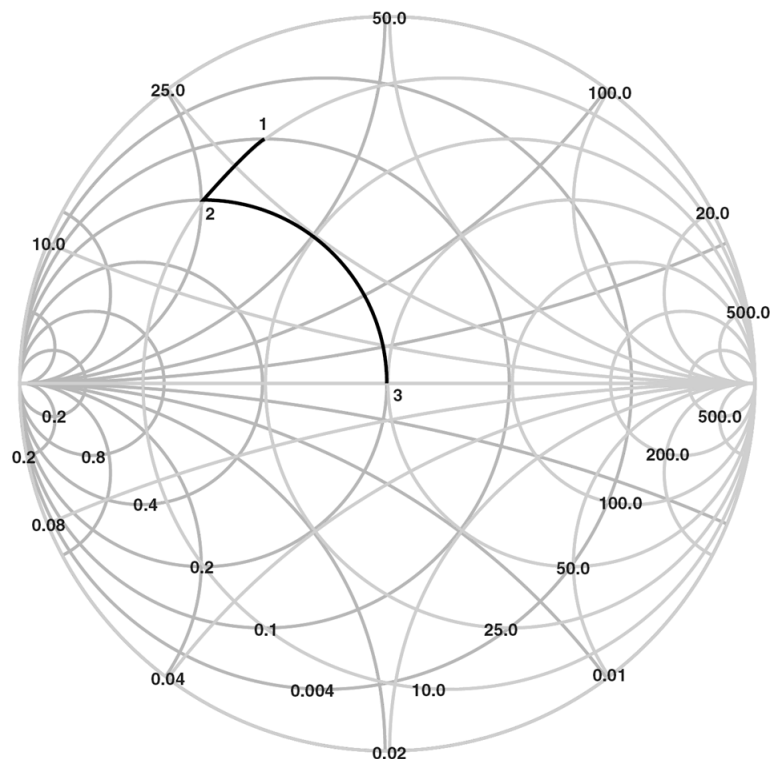

Figure 21. After Resistance-Conductance Tuning

The second technique is to move around the conductance circle and then the resistance circle by adding a shunt and series capacitance respectively, as shown in [Figure 22](#).

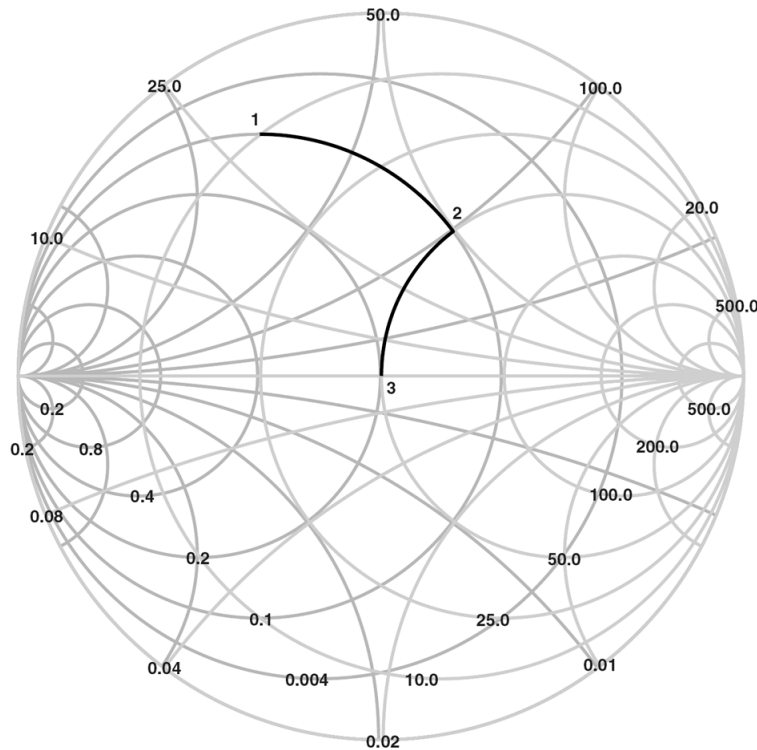

Figure 22. After Conductance-Resistance Tuning

The matching networks for the two methods are shown in [Figure 23](#).

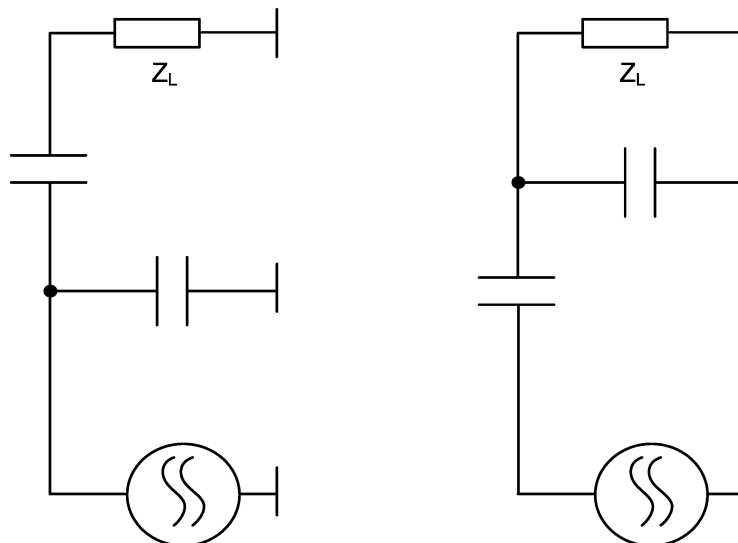

Figure 23. Two Possible Matching Networks

To allow both types of matching, a PI-pad must be used with the redundant gap bridged using a zero- Ω link.

However, so far we have only matched a single-point frequency to 50 Ω . In the case of a real passive device such as an antenna, the entire Bluetooth band has to be matched as closely as possible to 50 Ω . At least three frequency points have to be matched, as shown in [Figure 24](#).

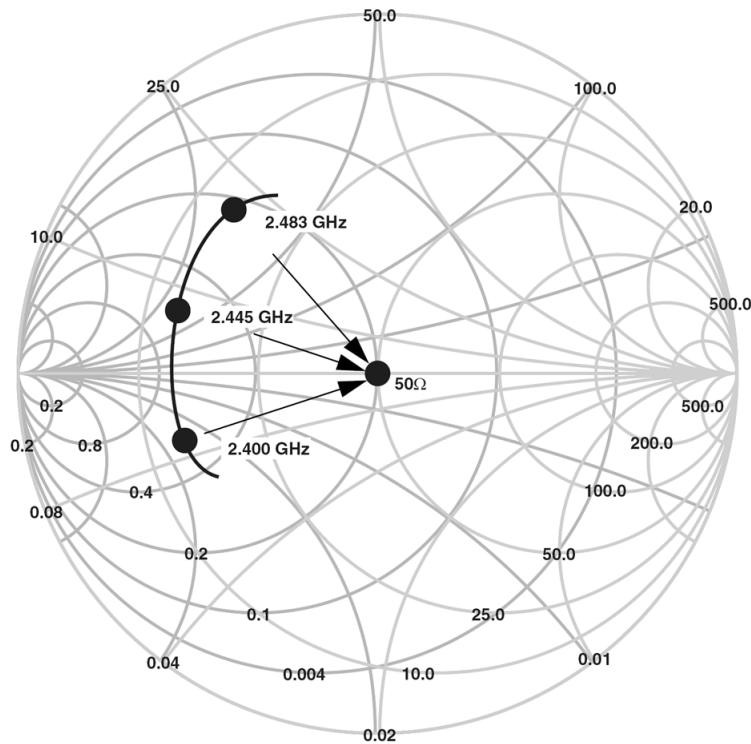

Figure 24. Broadband Match

The difficulty with making a broadband match to one frequency point is that the other two will go even further out! For example, 2.483 GHz can be brought closer to 50Ω by adding a shunt capacitor, but the 2.400 GHz point will move around the conductance circle creating an even larger mismatch at lower frequencies. A compromise must be found that will suit the entire band. This normally involves using simulation software such as HP-ADS (advanced design systems). If this is not possible, then a lot of manual tweaking is needed concentrating on the center frequency point.

First, the input impedance of the detuned antenna is measured using a network analyzer and saved as an S-parameters block, i.e. frequency points vs. impedance points across the Bluetooth band. This can then be entered into ADS along with the PI network, as shown in Figure 25.

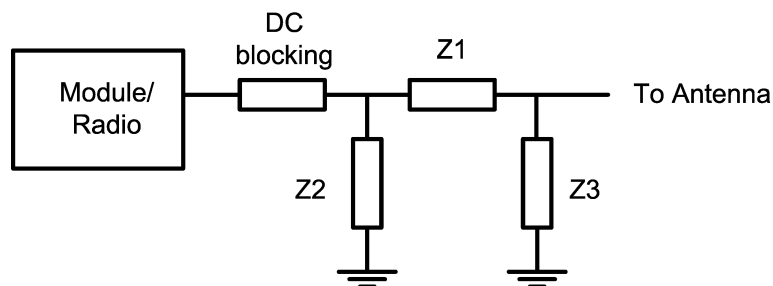

Figure 25. PI Network

To make the model more realistic, it is more effective to use real components with added parasitics rather than just pure inductance and capacitance. The models for the components with the parasitics are shown in Figure 26.

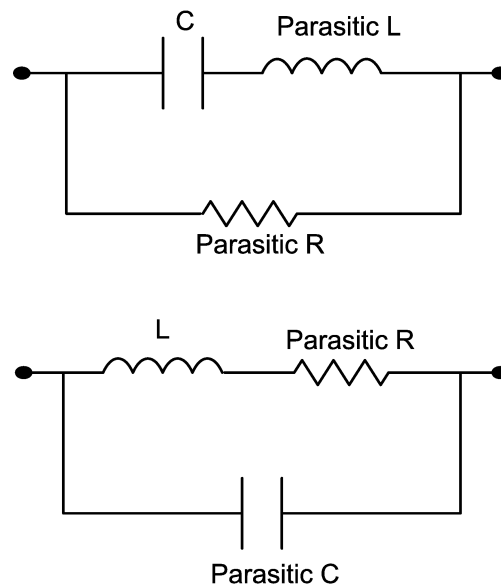

Figure 26. Component Models

Data for the parasitic values can be obtained from the component manufacturer.

Starting with the best possible values used to match 2.445 GHz, the model is entered into ADS, and an optimization procedure is set up to reduce S11 as much as possible in iterative steps from 2.400 to 2.483 GHz. The simulation finely tweaks the PI-pad component values and measures S11. If it is lower, then the components are tweaked again in the same direction until the best optimized solution is found.

The same procedure can be used for larger matching networks or even active networks, which may yield better results. However larger circuits will have higher insertion loss due to the parasitic resistance present within the components.

4.5 Matching to a Non-50Ω Active Source/Load Impedance

If the source and load impedances are both non-50Ω, then they can be matched in much the same way as a 50Ω impedance as shown in [Figure 27](#).

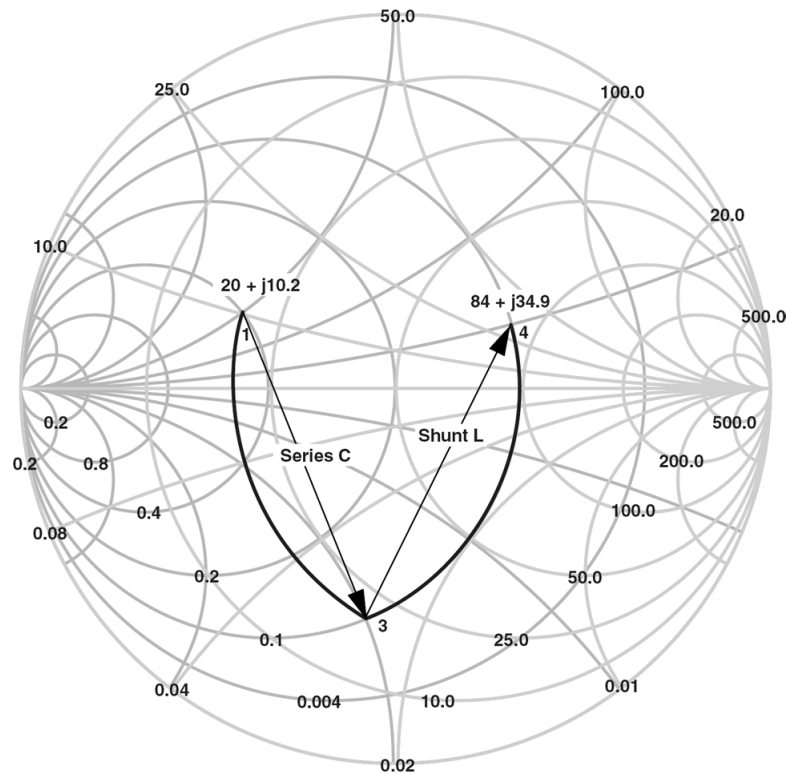

Figure 27. Matching to Non-50Ω Impedance

In this example the load is at $20 + j10$ and the source at $84 + j35$. A series capacitance and shunt inductance is required to transform the load impedance to that of the source.

Because these are non-50Ω, they can lie anywhere on the Smith Chart and must be measured using a vector network analyzer (VNA) to determine their exact value.

Measuring the input impedance of a receiver or passive antenna is simple. A calibrated VNA will display the value on its screen. However, when measuring the output impedance of a power amplifier or transmitter, this technique cannot be used because the power being transmitted will completely disrupt the VNA reading. The technique of conjugate matching using a variable load must be used.

In [Figure 28](#), a variable load and attenuator can provide any desired load impedance to the PA. Therefore, it can influence its output power which is measured using the power meter attached to the coupled port of the directional coupler. When a perfect conjugate match is applied to the output of the PA, the power measured on the power meter will be at its maximum, which signifies the best power transfer conditions.

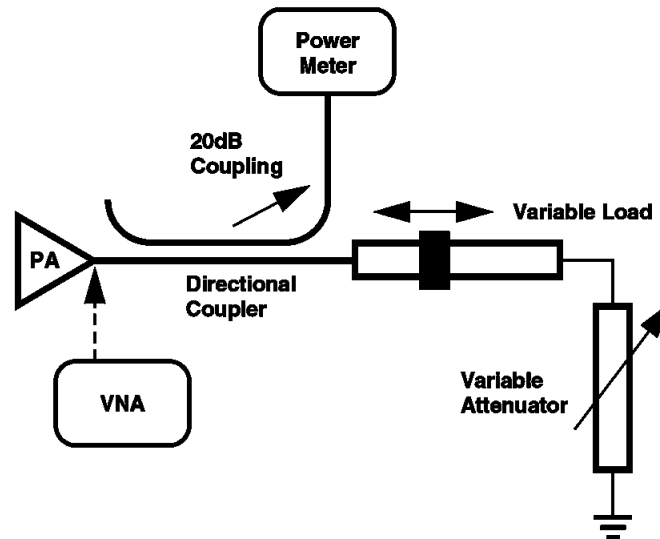

Figure 28. Setup for Determining Output Impedance

When best power transfer is achieved, the variable load and attenuator are fixed so that their impedance cannot be changed. The PA is detached from the directional coupler and a VNA attached to the input of the directional coupler to measure the input impedance at this point. The measured impedance is the conjugate of the output impedance of the PA, or if the impedance measured on the VNA is $R + jX$ then the output impedance of the PA will be $R - jX$ by definition.

Definition: the term conjugate match means that if in one direction from a junction the impedance is $R + jX$, then in the opposite direction the impedance will be $R - jX$. The condition for maximum power absorption by a load, in which the impedance seen looking toward the load at a point in a transmission line is the complex conjugate of that seen looking toward the source.

4.5.1 LMX5252 Impedance Match

In the case of the LMX5252 where the Tx and Rx impedances are different and slightly off 50Ω , two options are available for the antenna designer, either assume a 50Ω point for a simpler design, in which case a small miss-match will result causing a small degradation in Tx/Rx power. Or make a matching network as described above between two non- 50Ω points. In the first instance where a 50Ω input/output impedance is assumed the power loss that will result is as follows;

Worse case Rx input impedance = 32Ω

VSWR at this point = 1.5

Reflection coefficient S_{11} = 0.2

Return Loss = $10\text{LOG}(S_{11}) = 7\text{dB}$

Through transfer coefficient $S_{21} = \text{SQRT}(1-[S_{11}]^2) = 0.98$

Power transferred = $[S_{21}]^2 = 0.96$

Meaning that 96% of the power received by the antenna will be transferred to the receiver even with this miss-match. To achieve higher power transfer efficiency than this a non- 50Ω MN must be used as described above.

5 Interference Rejection

5.1 Filtering

An additional function of passive components in front of the antenna is to provide RF filtering. They may be used to create an 83-MHz pass-band window centered at 2.44 GHz for rejecting any unwanted signals outside the band that may impair the received signal quality. [Figure 29](#) shows how such a filter would look displayed on a Network Analyzer. It has three main features: within the pass-band is an unwanted Insertion Loss (IL) which attenuates the transmit and receive signals, outside the pass-band is a wanted rejection which attenuates interference, and at the edges of the pass-band is the filter roll-off which should be as steep as possible to form a sharp cut-off between the pass-band and rejection-band.

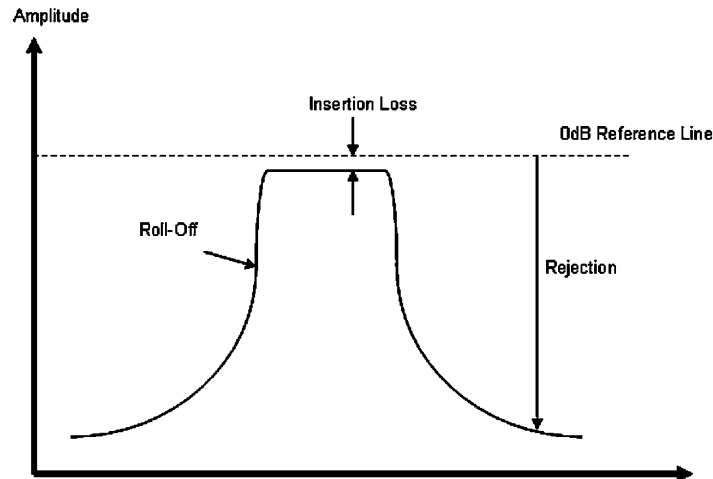

Figure 29. RF Filter Performance

5.1.1 Filter Types

The simplest type of passive filter is a capacitor and inductor in series. To visualize how this works, consider the response of a single capacitor and inductor in series to a frequency sweep. Looking at the capacitor response in [Figure 30](#), at DC it has very high IL, and as the frequency increases its IL decreases. The inductor has the opposite behavior; at DC its IL is very low and this increases as the frequency increases. The frequency at which the capacitor or inductor response changes will be dependent on its value, and the rate by which it changes will be dependent on its “Q” or quality factor. High Q-factor means rapid response change (steep roll-off) at a given frequency. By selecting the correct value of the capacitor and inductor, an LC filter can be formed at any desired frequency. But it is important to note that the higher the frequency of the filter, the lower will be its Q-factor and hence its roll-off.

A 1-pF capacitor in series with a 3.3-nH inductor forms an LC filter with a center frequency of 2.44 GHz. Using high-Q components yields better roll-off and out-of-band rejection.

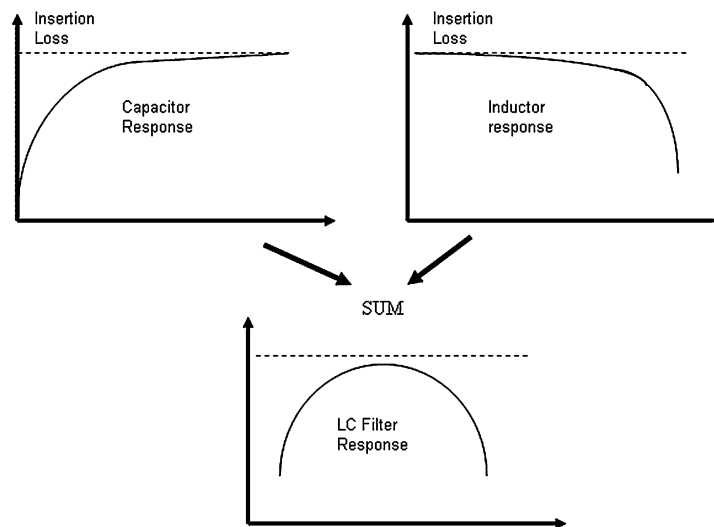

Figure 30. LC Filter Response

However, even a well designed LC filter at 2.4 GHz does not provide very good roll-off and out-of-band rejection. Typically, it will provide 10 dB of rejection below 1 GHz and above 3.5 GHz, however interference signals will get through at closer frequencies. A better but more expensive solution is to use a ceramic chip filter. These can be purchased from manufacturers such as Murata and M/A-COM. An example of a Murata filter is the LFB212G45SG8A166. [Table 1](#) lists its electrical specifications.

Table 1. Chip Filter Specifications

Specification	Value
Nominal Center Frequency (fo)	2450 MHz
Bandwidth (BW)	fo ± 50 MHz
Insertion Loss in BW I	1.4 dB max. @ 25°C
Insertion Loss in BW II	1.6 dB max. @ -40 to +85°C
Attenuation (AbsoluteValue) I	30 dB min. @ 880 to 915 MHz
Attenuation (AbsoluteValue) II	30 dB min. @ 1710 to 1910 MHz
Attenuation (AbsoluteValue) III	6 dB min. @ 2110 to 2170 MHz
Attenuation (AbsoluteValue) IV	20 dB min. @ 4800 to 5000 MHz
Ripple in BW	0.8 dB max.
VSWR in BW	2 max.
Characteristic Impedance (Nom.)	50Ω
Power Capacity	500 mW
Min. Operating Temperature	-40°C
Max. Operating Temperature	+85°C

The IL may be slightly worse than an LC filter, but the out-of-band rejection is significantly better (20 to 30 dB). The filter is approximately 2 × 1.5 mm in size, and it is rated over the full automotive temperature range (-40 to +85°C). A noteworthy but unwanted feature is the in-band ripple. The specification is 0.8 dB, which means that the IL varies by 0.8 dB within the pass-band. The ripple will get worse as the input/output impedances presented to the filter deviate from 50Ω, and this will give rise to variable sensitivity and output power across the band.

5.2 Blocking

The Bluetooth receiver compliance test measures the receiver performance under the effect of a strong out-of-band interfering signal. A wanted signal is set to 2460 MHz at 3dB above reference sensitivity, and an interfering signal is applied at the levels shown in [Table 2](#).

Table 2. Blocking Signal Level and Frequency

Interfering Signal Frequency	Power
30 MHz-2000 MHz	-10 dBm
2000 MHz-2400 MHz	-27 dBm
2500 MHz-3000 MHz	-27 dBm

The blocking signal is stepped in intervals of 1 MHz from 30 MHz to 12.75 GHz. Several thousand test points are used, and at each of these points the bit error rate (BER) of the wanted signal must remain under 0.1%. A total of 24 exceptions are allowed, because it is very difficult to pass all test points.

Failures are due to insufficient front-end filtering, either due to direct saturation of the front end if the low-noise amplifier (LNA) is not able to tolerate -10 dBm or more commonly due to mixing products entering the pass-band. Unwanted products are caused by the blocking signal mixing with harmonics of other signals present near the front end, such as clocks and local oscillators. By eliminating the interfering signal using filtering, blocking failures can be reduced. Good layout techniques also help avoid the mixing products.

5.2.1 Blocking Qualification Testing

During Bluetooth qualification, the Bluetooth Qualification Task Force (BQTF) uses the TS8960 test set to link to the device under test (DUT) and place it on a fixed 2460-MHz receive channel. A signal generator and combiner is used to produce the interfering signal. The whole setup is controlled with automated test equipment (ATE), because there are several thousand points to test. This takes up to two days of continuous measurements. Failures are counted when the BER exceeds 0.1%, however at times the BER on certain blocking frequencies goes so high that the link is dropped, and a new link must be initialized before testing can resume. When this happens, one or more failing frequencies may be reported. It is the responsibility of the DUT manufacturer to test these failing frequencies manually and determine whether additional filtering is required. During the link failure and re-establishment, the ATE system sometimes logs more failures than are actually present, so manual testing will also confirm whether these failures are genuine.

5.3 Recommended Front-end Layout and Matching

The front-end layout shown in [Figure 31](#) or [Figure 32](#) is recommended to provide the best matching and filtering while at the same time providing flexibility for modifying the circuit as needed to meet the Bluetooth testing requirements. [Figure 31](#) is for a ceramic filter and blocking capacitor with good out-of-band rejection, dimensions shown here are non-exact. Alternatively the layout shown in [Figure 32](#) maybe used to form a simpler and cheaper LC filter and to allow matching to the antenna.

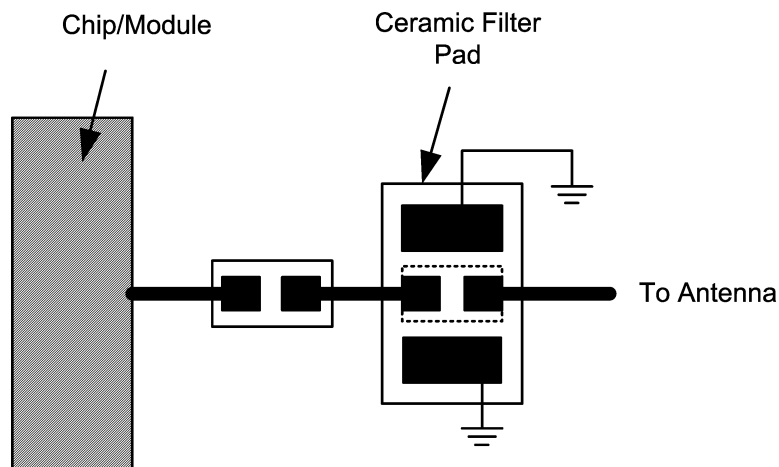

Figure 31. Front-end Layout Using Ceramic Filter

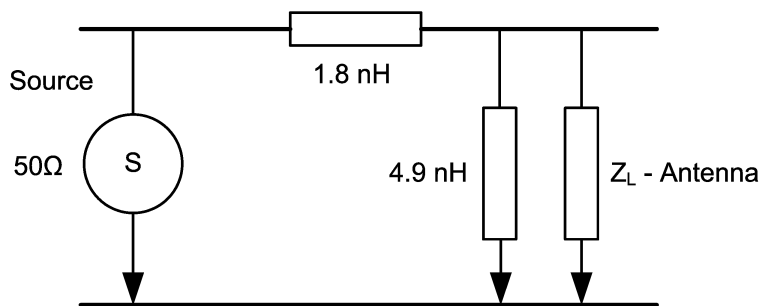

Figure 32. Front-end Layout Using T PI Pad

6 Antenna Vendors

Table 3 lists vendors for off-the-shelf antenna products and custom designs.

Table 3. Antenna Vendors

Vendor	Products	Contact Information
gigaAnt	Small ceramic chips and larger surface-mount antennas suitable for mobile phones, headsets and laptops, printers, etc.	gigaAnt Ideon Science & Technology Park S-223 70 Lund Sweden Phone: +46 46 286 41 77 Web: www.gigaant.com E-mail: info@gigaant.com
	For example, 3030A5839-01 Leftside, 3030A5887-01 Rightside.	
Mitsubishi Materials	Small ceramic chips for surface-mount. Suitable for mobile applications	Mitsubishi Materials Corporation Advanced Products Strategic Company Sales Group, Electronic Components 1-297, Kitabukuro-cho, Omiya-ku Saitama-city, Saitama, 330-8508 Japan
		Phone: +81 48 641 5991 Fax: +81 48 641 5562 Web: www.mmc.co.jp E-mail: devsales@mmc.co.jp
Tyco Electronics	Large high-gain printed antennas for applications such as access points.	Tyco Antenna Products/Rangestar 350 Metro Park Rochester, NY 14623 USA
	Small ceramic chips for surface-mount. Suitable for mobile applications	Phone: (585) 272-3103 Fax: (585) 272-3110 Web: www.rangestar.com
Centurion	PCB surface-mount antennas for various applications.	Centurion Wireless Technologies PO Box 82846 Lincoln, NE 68501 USA
		Phone: (402) 467-4491 Fax: (402) 467-4528 Web: www.centurion.com E-mail: sales@centurion.com

Table 3. Antenna Vendors (continued)

Vendor	Products	Contact Information
Murata	PCB surface-mount antennas	Murata International Sales Dept. 3-29-12 Shibuya, Shibuya-ku Tokyo 150-0002 Japan
	For example, M1 series ANCM12G45SAA072 or W1 series ANCW12G45SAA110TT1.	Phone: +81 3 5469 6123 Fax: +81 3 5469 6155 Web: www.murata.com E-mail: intl@murata.co.jp

7 Comparison Summary

Table 4 compares the features of different antenna types.

Table 4. Antenna Comparison

Antenna Type	Performance	Profile	Cost	Physical Size
Stub helix or monopole	Good bandwidth and efficiency, does not require matching network.	High: Projects from the side of the PCB	High	2.4 GHz antenna is approximately 15 mm long, but projects. Does not need ground plane to function.
Surface-mount ceramic chip	Reasonable performance on $\lambda/4$. Small bandwidth and reduced efficiency. Can become detuned during handling	Low: Can be machine mounted during assembly, no more than 0.5 mm thick	Medium	Element for 2.4 GHz is approximately 12 mm long, but needs ground area and clearance around active region.
Printed inverted-F or other printed types	Reasonable performance on $\lambda/4$. Small bandwidth and reduced efficiency. Can become detuned during handling	Lowest: Printed on PCB	Low	Element for 2.4 GHz is approximately 25 mm long, but needs ground area and clearance around active region.

8 Points for Consideration

- Many types of antennas are available.
- Antenna type is chosen to fit the application.
- Larger antennas generally have better performance than smaller ones.
- Ground plane is always required with printed or ceramic antennas.
- Cannot put metal objects such as crystals close to antenna without causing detuning.
- The case of a phone or other device will also detune the antenna, so some tuning adjustment ability is needed.
- Matching elements have parasitic values that affect their quality; this is not possible to simulate using simple simulation software. Some trial and error is therefore required when performing the match or a sophisticated simulation tool must be used.
- The LMX9820A shielding will act as the ground plane for the antenna if placed correctly.
- The LMX5251/LMX5252 radio chip must be shielded from the strong electric field only if it is placed close to the radiating element. Shielding will improve performance but is not always required.

9 Examples of Antennas Used With LMX5251/LMX5252

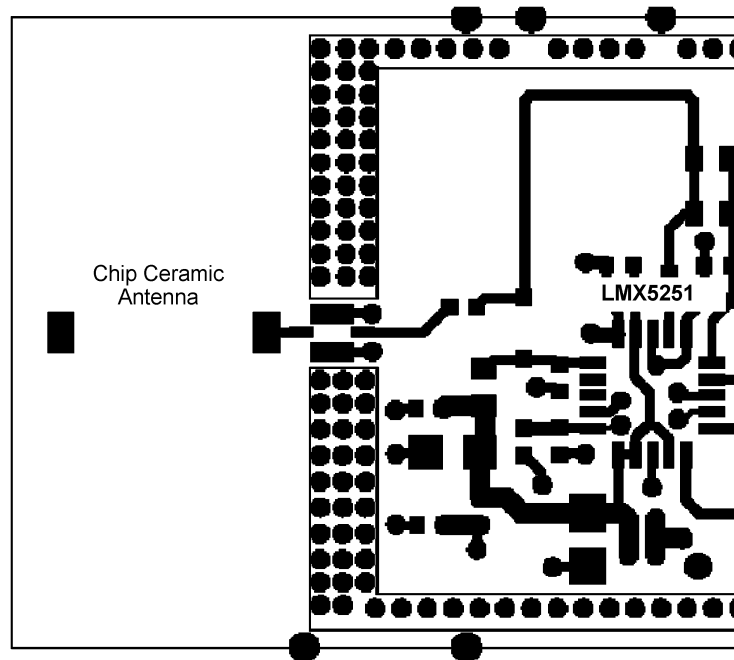

Figure 33. Ceramic Chip Antenna for Industrial Remote Control with External PA

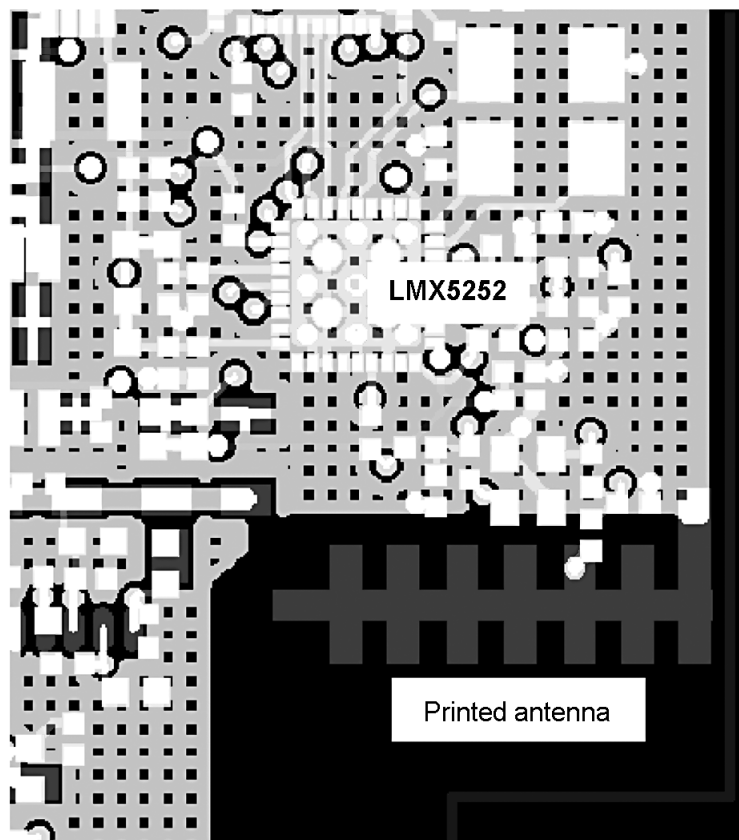

Figure 34. Printed Antenna—Monopole Yagi-Array for Off-Board Navigation Using GPS

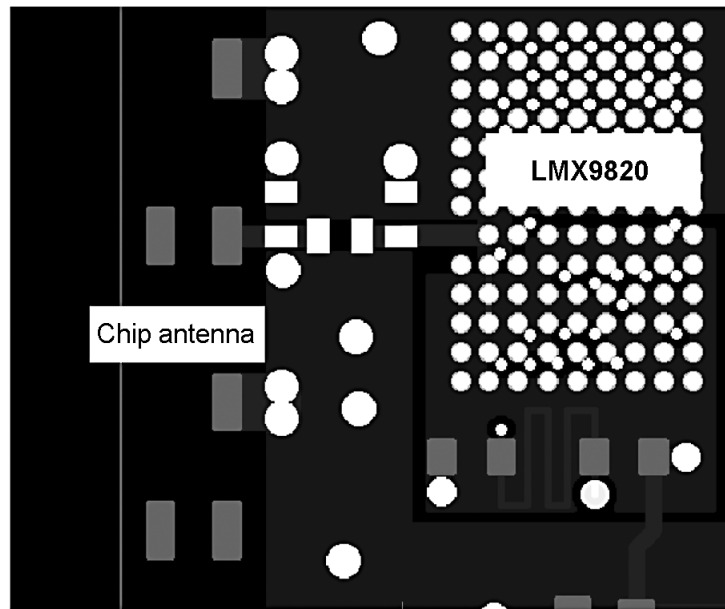

Figure 35. Ceramic Chip Antenna for Intelligent Remote Access for Car Lock

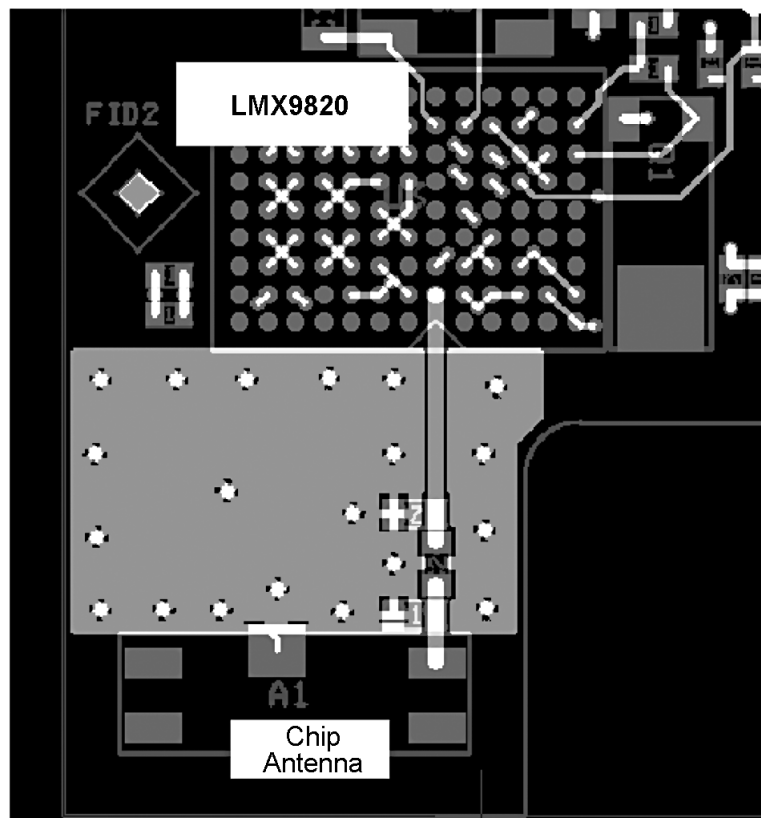

Figure 36. Ceramic Chip Antenna for Distance Meter

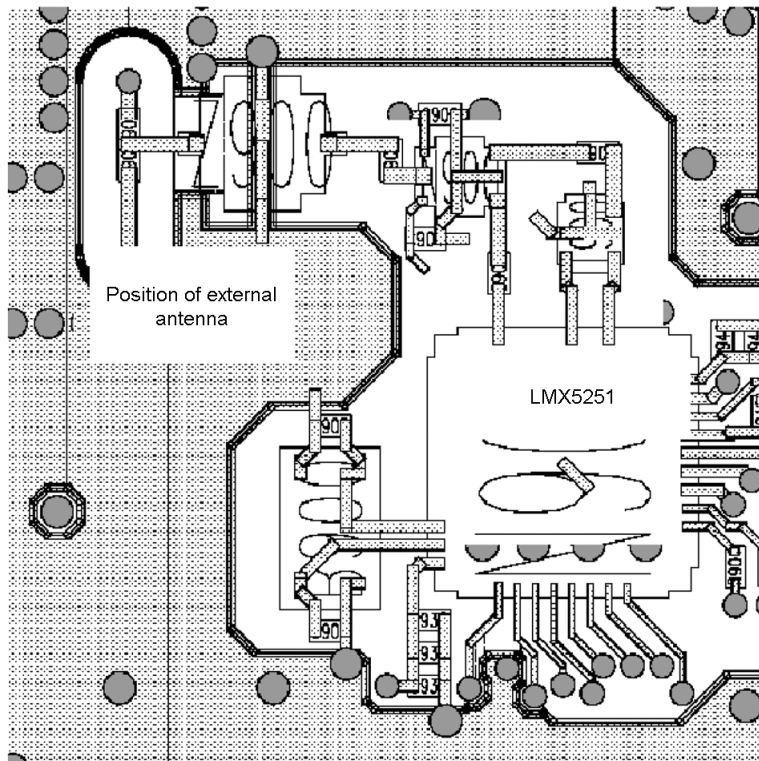

Figure 37. External Antenna—Helix or Monopole for Automotive Integrated Hands-Free Kit

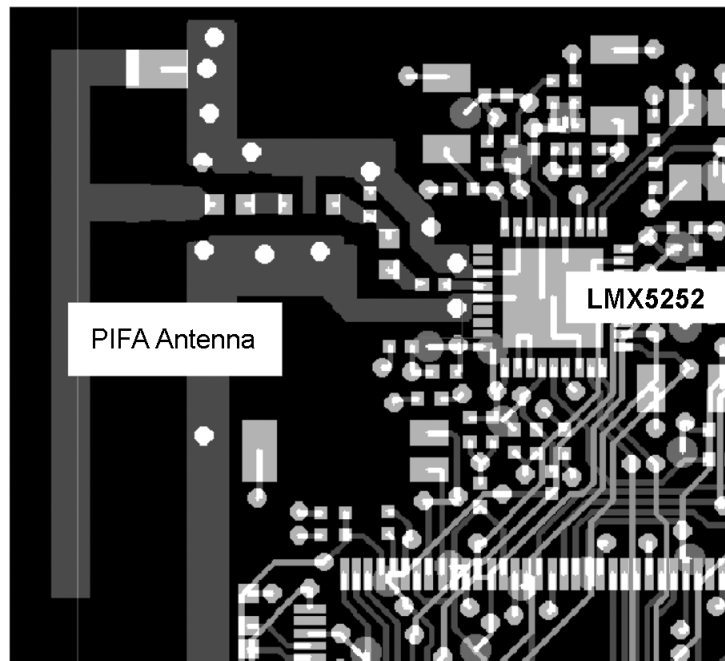

Figure 38. Printed PIFA Antenna for Automotive Hands-Free Kit

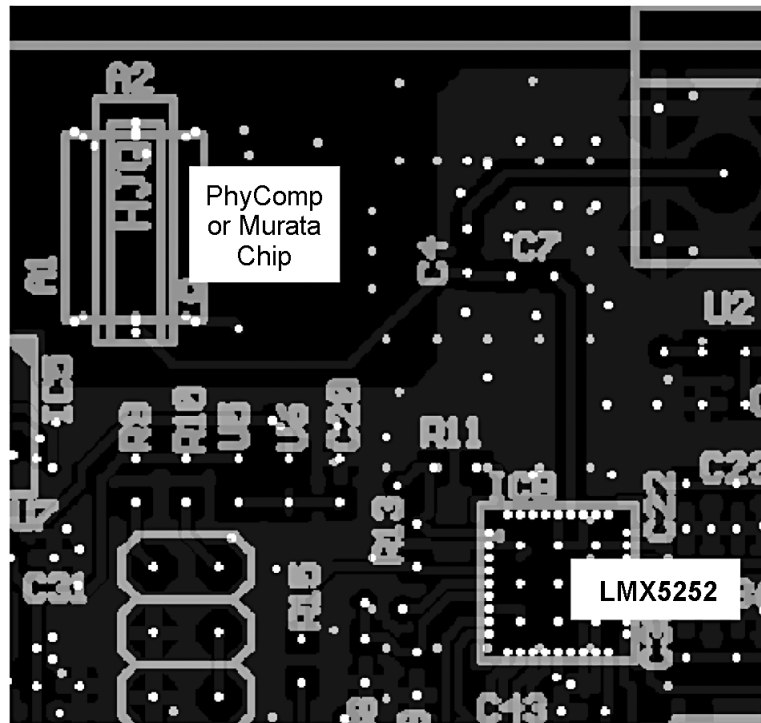

Figure 39. Surface-Mount Chip Antenna (Phycomp AN-2700 or Murata ANCM12G) for Automotive Hands-Free Kit

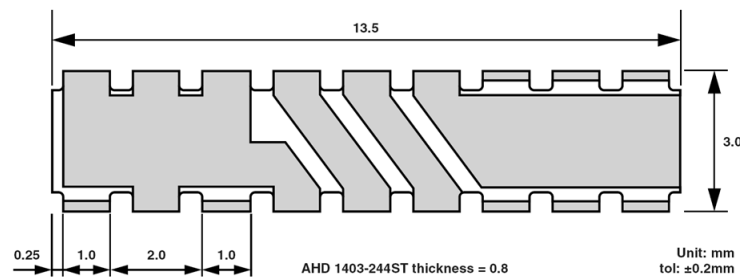

Figure 40. Surface-Mount Chip Antenna (Mitsubishi Materials AHD 1403) for Electronic Whiteboard

10 Popular Antenna Types

Ceramic chip antennas (Mitsubishi, gigaAnt) are the most popular types being used in Bluetooth products. These cost about 40 cents/unit.

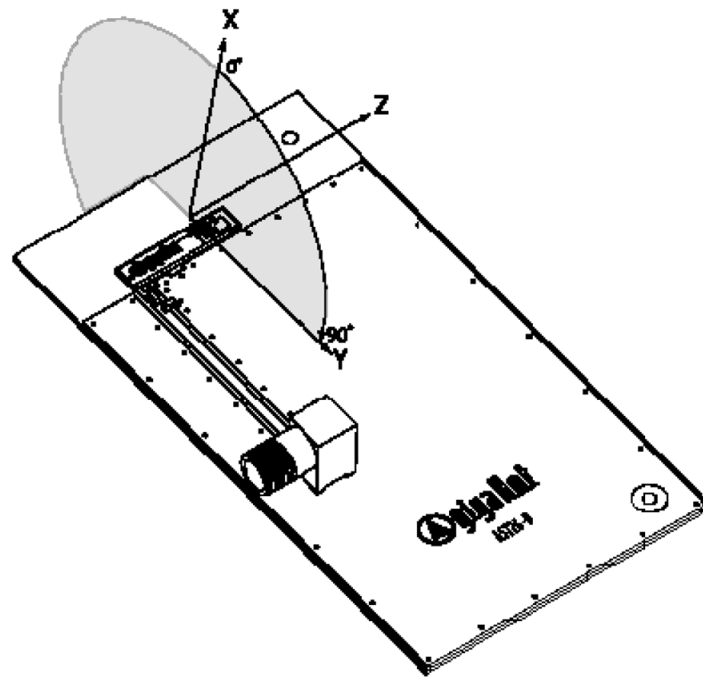

Figure 41. GigaAnt Rufa 2.4 GHz SMD Antenna

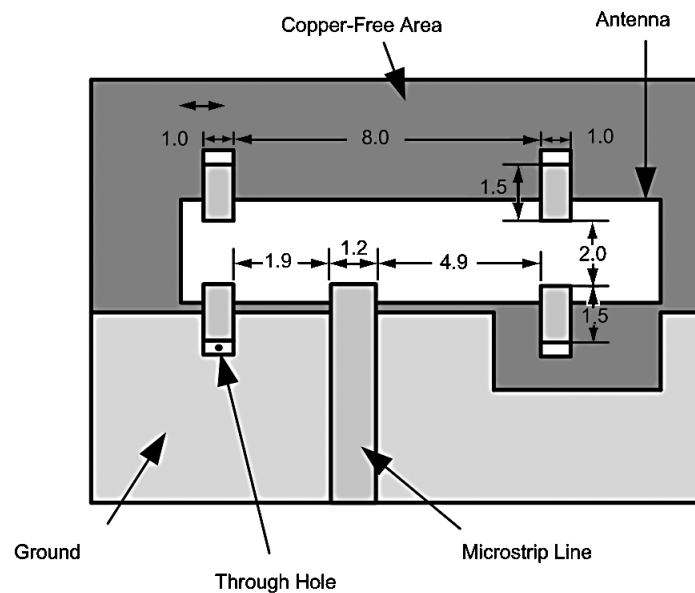

Figure 42. Mitsubishi AHD1403 Surface-Mount Antenna

The second most popular type is the PIFA. These have the lowest cost because they consist of a PCB trace, but are larger and more design-intensive.

IMPORTANT NOTICE

Texas Instruments Incorporated and its subsidiaries (TI) reserve the right to make corrections, enhancements, improvements and other changes to its semiconductor products and services per JESD46, latest issue, and to discontinue any product or service per JESD48, latest issue. Buyers should obtain the latest relevant information before placing orders and should verify that such information is current and complete. All semiconductor products (also referred to herein as "components") are sold subject to TI's terms and conditions of sale supplied at the time of order acknowledgment.

TI warrants performance of its components to the specifications applicable at the time of sale, in accordance with the warranty in TI's terms and conditions of sale of semiconductor products. Testing and other quality control techniques are used to the extent TI deems necessary to support this warranty. Except where mandated by applicable law, testing of all parameters of each component is not necessarily performed.

TI assumes no liability for applications assistance or the design of Buyers' products. Buyers are responsible for their products and applications using TI components. To minimize the risks associated with Buyers' products and applications, Buyers should provide adequate design and operating safeguards.

TI does not warrant or represent that any license, either express or implied, is granted under any patent right, copyright, mask work right, or other intellectual property right relating to any combination, machine, or process in which TI components or services are used. Information published by TI regarding third-party products or services does not constitute a license to use such products or services or a warranty or endorsement thereof. Use of such information may require a license from a third party under the patents or other intellectual property of the third party, or a license from TI under the patents or other intellectual property of TI.

Reproduction of significant portions of TI information in TI data books or data sheets is permissible only if reproduction is without alteration and is accompanied by all associated warranties, conditions, limitations, and notices. TI is not responsible or liable for such altered documentation. Information of third parties may be subject to additional restrictions.

Resale of TI components or services with statements different from or beyond the parameters stated by TI for that component or service voids all express and any implied warranties for the associated TI component or service and is an unfair and deceptive business practice. TI is not responsible or liable for any such statements.

Buyer acknowledges and agrees that it is solely responsible for compliance with all legal, regulatory and safety-related requirements concerning its products, and any use of TI components in its applications, notwithstanding any applications-related information or support that may be provided by TI. Buyer represents and agrees that it has all the necessary expertise to create and implement safeguards which anticipate dangerous consequences of failures, monitor failures and their consequences, lessen the likelihood of failures that might cause harm and take appropriate remedial actions. Buyer will fully indemnify TI and its representatives against any damages arising out of the use of any TI components in safety-critical applications.

In some cases, TI components may be promoted specifically to facilitate safety-related applications. With such components, TI's goal is to help enable customers to design and create their own end-product solutions that meet applicable functional safety standards and requirements. Nonetheless, such components are subject to these terms.

No TI components are authorized for use in FDA Class III (or similar life-critical medical equipment) unless authorized officers of the parties have executed a special agreement specifically governing such use.

Only those TI components which TI has specifically designated as military grade or "enhanced plastic" are designed and intended for use in military/aerospace applications or environments. Buyer acknowledges and agrees that any military or aerospace use of TI components which have **not** been so designated is solely at the Buyer's risk, and that Buyer is solely responsible for compliance with all legal and regulatory requirements in connection with such use.

TI has specifically designated certain components as meeting ISO/TS16949 requirements, mainly for automotive use. In any case of use of non-designated products, TI will not be responsible for any failure to meet ISO/TS16949.

Products

Audio	www.ti.com/audio
Amplifiers	amplifier.ti.com
Data Converters	dataconverter.ti.com
DLP® Products	www.dlp.com
DSP	dsp.ti.com
Clocks and Timers	www.ti.com/clocks
Interface	interface.ti.com
Logic	logic.ti.com
Power Mgmt	power.ti.com
Microcontrollers	microcontroller.ti.com
RFID	www.ti-rfid.com
OMAP Applications Processors	www.ti.com/omap
Wireless Connectivity	www.ti.com/wirelessconnectivity

Applications

Automotive and Transportation	www.ti.com/automotive
Communications and Telecom	www.ti.com/communications
Computers and Peripherals	www.ti.com/computers
Consumer Electronics	www.ti.com/consumer-apps
Energy and Lighting	www.ti.com/energy
Industrial	www.ti.com/industrial
Medical	www.ti.com/medical
Security	www.ti.com/security
Space, Avionics and Defense	www.ti.com/space-avionics-defense
Video and Imaging	www.ti.com/video

TI E2E Community

e2e.ti.com